

*Circus.*



Miracles happened under the looko tent

+86-199 2559 6173

www.lookotent.com

+86-0766-255 6888

sales03@lookotent.com

Superb Tech Park, 9 Wanyang Avenue, Xincheng,  
Xinxing, Yunfu, Guangdong, China, 527400



Wechat



WhatsApp



Web

# LOOKO TENT

## CIRCUS TENT CATALOGUE



# CONTENTS

## I Company Profile

01~04

## II Product Features & Advantages

05~08

## III Project case

09~18

## IV Supporting facilities

19~24

# COMPANY CERTIFICATES



High—tech Enterprises



SGS Audited Supplier



Exhibition Projects Certificate



Re-contract And Trustworthy Enterprise Certificate



Chief Editor Of Industry Standard



Business License



ABS Walls Test Report



Structure Engineer Certificate



CQC Certificate



Flame retardant Certificate



Director Of The Certificate



Fabric Test Report NFPA 701 - AFTER 72hr



Supplier Assessment Certificate



Brand Enterprise Certificate



Fabric Test Report NFPA 701 INITIAL



Tempered Glass Test Report



Aluminium Material Test Report



ABS Sidewall Test Report



ISO 9001:2015 Certificate



## ABOUT LOOKO

Looko Tent Co.,Ltd. is one of the market leaders in design, manufacture and supply of Aluminum-PVC tents in China. The company's headquarters and production base are located in Foshan City (hometown of hardware), The city that supplies 80% of PVC materials & aluminum in China. In 2022, set up a new R&D base in Yunfu city which is up to 70000sqm to meet the growth of production capacity.

Main products of Looko Tent are modular aluminum movable tents with clear span from 3 meters up to 60 meters on standard A frame shape tents, circus tent, arcum tents, curve tents, pagoda tents, multi-sided and high peak tents combinations tents, polygon tents, double decker, peak marquee tents, pole tents and customized tents.

Professional personnel of Looko Tent are all high-technique and innovative design oriented, their expertise and abundant experience since 1997 guarantee the designing and manufacturing, renting and selling organized by Looko Tent are efficient, outstanding and beyond comparison in the whole industry, Companies products have been exported all over the world, including North America, South America, Europe, Middle East, Africa, Asia and etc.

Looko Tent's production line uses advanced machines like European CNC machine, American automatic hot-welding machines and other advanced machines to improve production efficiency and quality, to maintain a monthly production over 100000 m<sup>2</sup>.

Focused on details of improvements and strict quality control management in accordance with ISO9001, Looko Tent committed to maximize the satisfaction of all clients. The principle of Looko Tent is: Taste comes from details and Innovation improves status.

Looko Tent is looking forward to cooperate with you to make greater achievements in the future!

# PRODUCT CHARACTERISTICS

Introduced foreign advanced equipment into production line, realized semi-automated production.

High efficiency, high precision, stable performance.

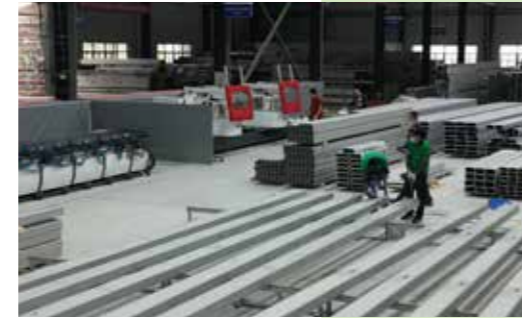

CNC Slot milling machine



Robot welding operation



Automatic casing cutter



CNC Machines



Automatic welding creeper



CNC fabric feeder

# PRODUCT DISPLAY

Product Features

Product Advantages

Product Display



# PRODUCT FEATURES

## ▼ LONG SERVICE LIFE

The membrane material is sourced from the German brand Hettich, specifically the PVDF outdoor tensioned membrane, a professional international circus tent fabric with an added black layer. The interior is dark blue, ensuring 100% light-blocking property and UV-resistant, and it meets a service life of 8-10 years.

## ▼ MOBILITY

This product can be used for long-term use as a sturdy ground hardening according to customer needs, it can also be used in combination with the actual foundation conditions for short-term use, with strong mobility and convenient maintenance.

## ▼ WIND LOAD

The frame is made of international Q235 carbon steel, with a painted surface treatment, featuring wear resistance, rain resistance, wind resistance up to level 10, and heat resistance from -30°C to +70°C, The snow load can reach 50~70cm<sup>2</sup>.

## ▼ FASHION

With the advent of the e-commerce era, people's pursuit of architectural aesthetics has become increasingly high. The shape and color matching of this product having experienced the combination of multiple elements and colors, it can satisfy people's pursuit of fashion trends.

# PRODUCT FEATURES

## ▼ STEEL STRUCTURE

External suspension and internal support tents.

## ▼ TENT-SHAPED DESIGN

Square, round, arched canopy, and special-shaped canopy.

## ▼ CANOPY

Single-top, double-top, and multi-top tents.

Spire-top, cone-top, and arc-top tents.

## ▼ TENT COLOR

The standard colors are black and blue (customizable).



# PRODUCT ADVANTAGE

## 1 UNIQUE DESIGN

Each tent is meticulously designed by a designer in combination with practical considerations, with modeling, cutting, sampling, and cutting all being carried out through integrated computer operations.

## 3 DELIVERY SPEED

With a top-tier production team and dedicated technical elites, we ensure timely delivery of products with guaranteed quality and quantity, aiming to achieve customer satisfaction.

## 2 COLORFUL PALETTE

The color matching of each tent combines aesthetics, optics, physics principles, and customer needs, with unique decorative combinations that strive for excellence.

## 4 GOOD AND CHEAP

The raw materials of the same grade are of superior quality and priced no higher than the industry standard. Building a tent performance theater with tents saves more investment than constructing a performance building, and it complements the scenic area to better attract attention.

## 5 AFTER-SALES SERVICE

After the goods are shipped, after-sales warranty is guaranteed. Under normal use conditions, the free warranty period is 1 year, and we provide 24/7 after-sales service guarantee. We will arrive at the scene within 48 hours after receiving notification and handle it promptly.



## PROJECT CASE



## DOUBLE POLE STYLE

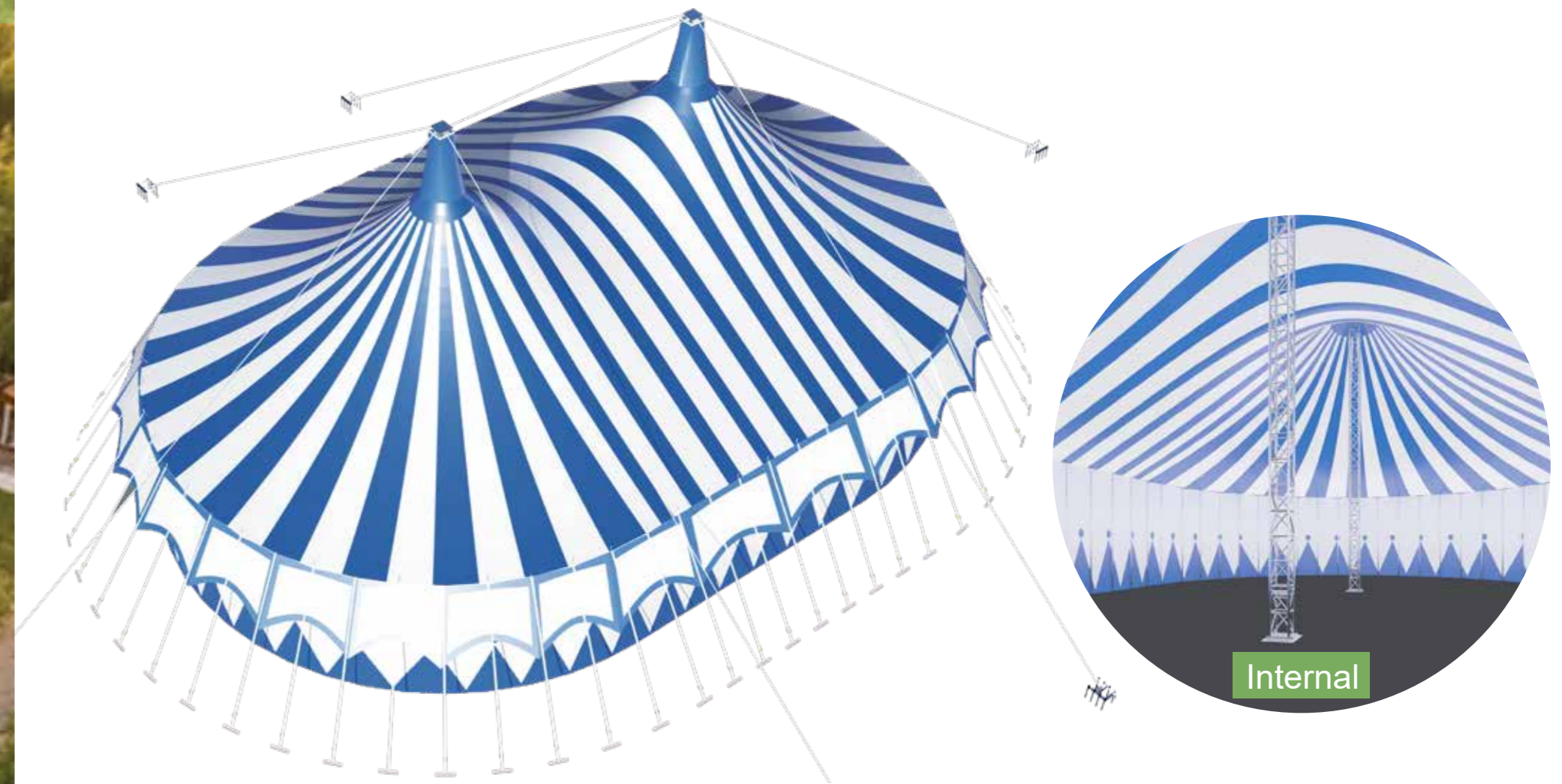

The top of the double-column circus tent is supported by two tall pillars, forming a spacious space. It is fixed to the internal equipment steel frame through steel wire ropes, and the lower part of the sunshade is fixed to the internal structure of the equipment. The upper part of the sunshade is attached to the exterior of the equipment steel frame.



# FOUR POLE STYLE

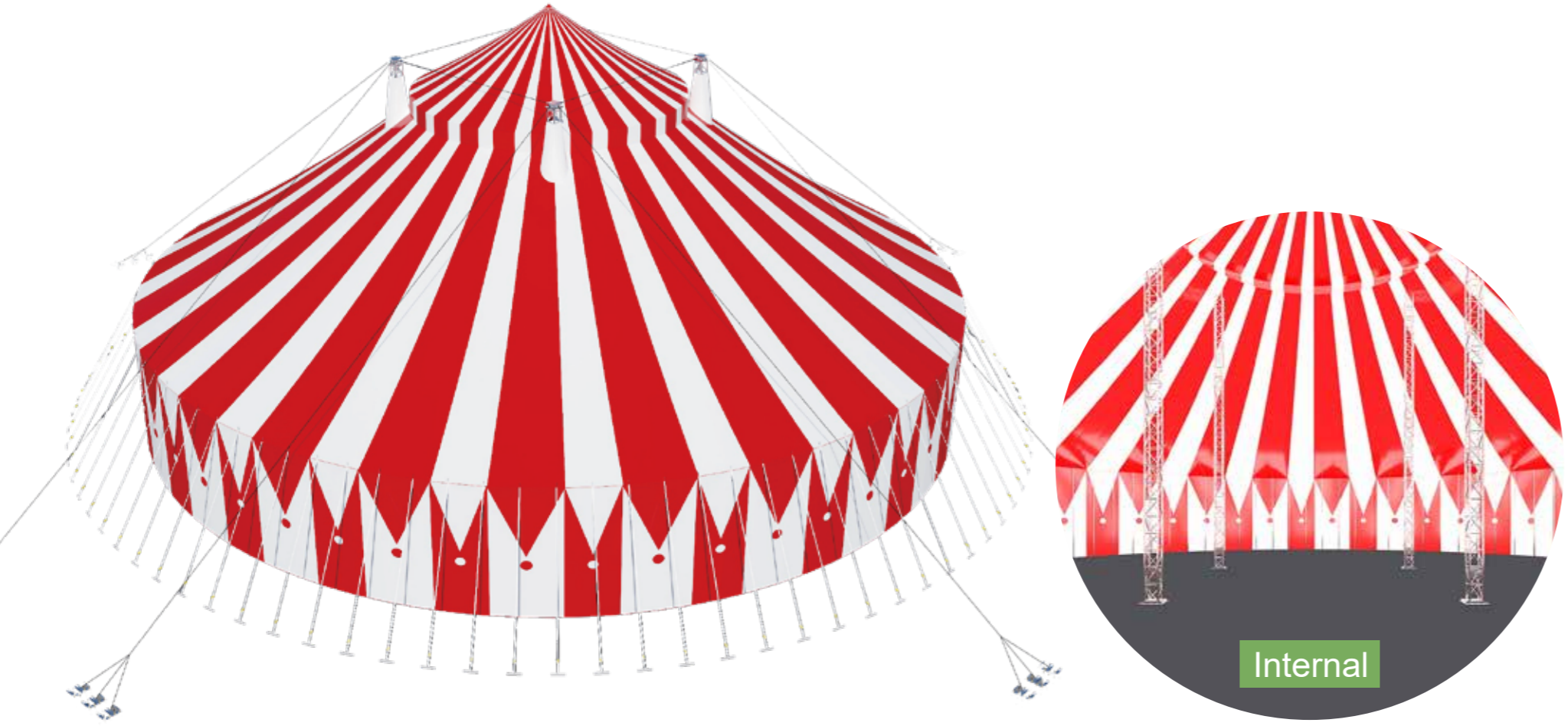

The main canopy is made of high-density spunbonded fabric with an internal support structure, including a steel frame (i.e., steel structure) and a sunshade (i.e., membrane structure). Under the steel canopy, the stage is circular.



# CIRCUS WITH ARCH



The fabric is fixed to the internal equipment steel frame through steel wire ropes, and its lower part is secured to the internal structure of the equipment; the upper part of the awning is attached and fixed to the exterior of the equipment steel frame.



# EXTERNAL HANGING STYLE



The structural design requirements for the main canopy are as follows: a single-unit external hanging structure, comprising a steel frame (i.e., steel structure) and a sunshade canopy (i.e., membrane structure). The steel frame is composed of a semi-arch supporting structure. The sunshade canopy is fixed to the internal equipment steel frame via steel wire ropes, and its lower part is secured to the internal structure of the equipment; the upper part of the sunshade canopy is attached to the exterior of the equipment steel frame.



# SUPPORTING FACILITIES



The internal stands and seats are arranged according to the layout of higher seats on the outer ring and lower seats on the inner ring, with conventional seats and VIP seats provided;

The middle of the main column forms a performance area, which can be equipped with a stage, a horse racing track, and an aerial performance area;

The curtain system, horse racing track, performance stage, death wheel, and aerial rigging are optional.

Material quality: Plastic  
Color: Can Be Customizable

## SEAT

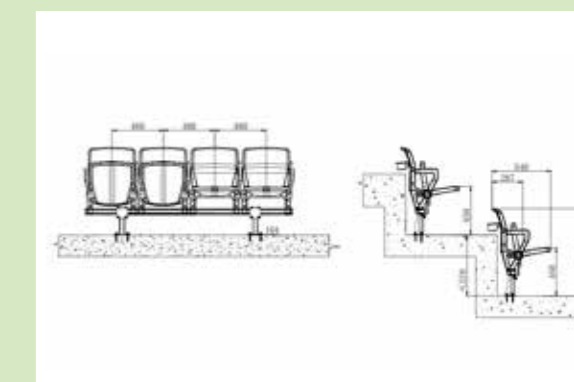
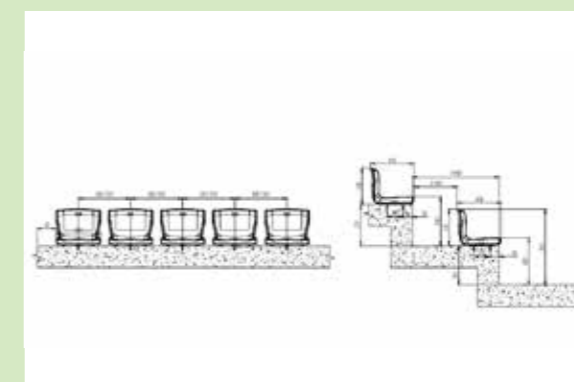
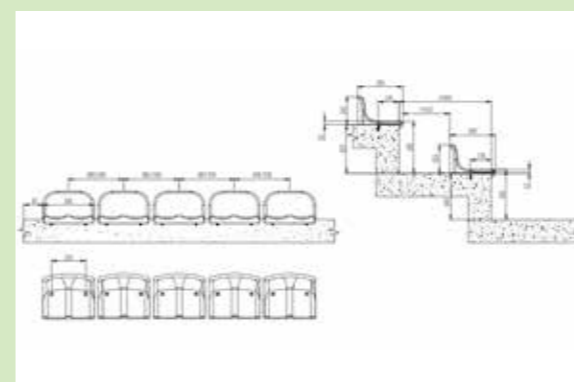
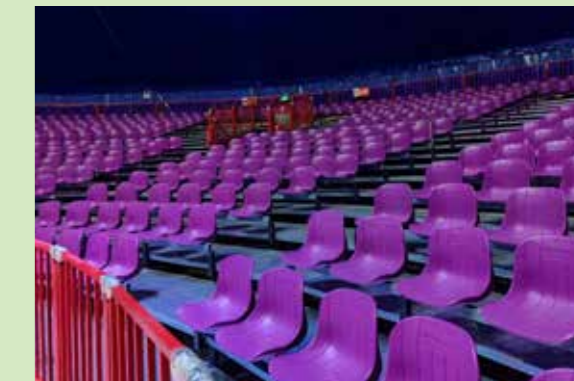

Basic seats

Intermediate seats

Premium seats



## LIGHTING FACILITIES



## PERFORMANCE STAGE

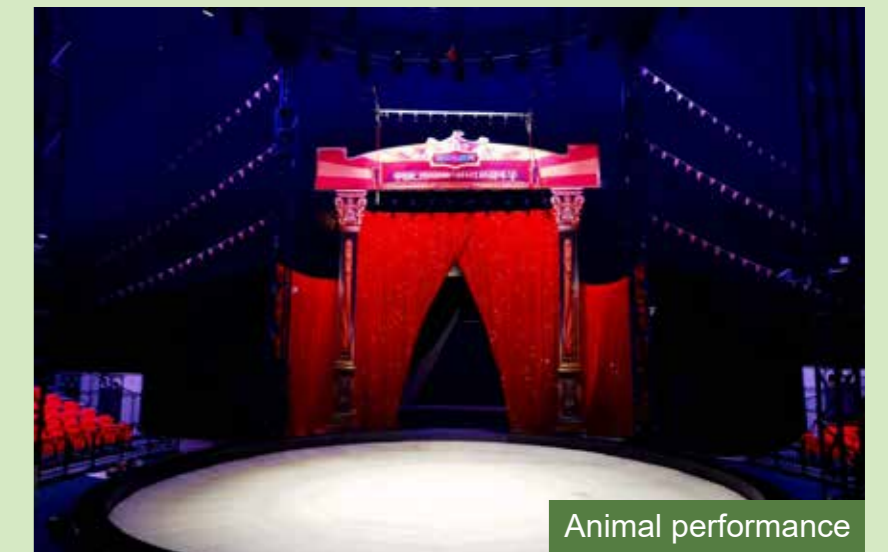

12m/14m/16m/Can Be Customizable

# ADJUSTABLE FLOOR



# TICKET BOOTH



# BASE FRAME AND RAILING



Scaffolding style system



European tripod system



Guardrail system